

# KT-300

Door Controller

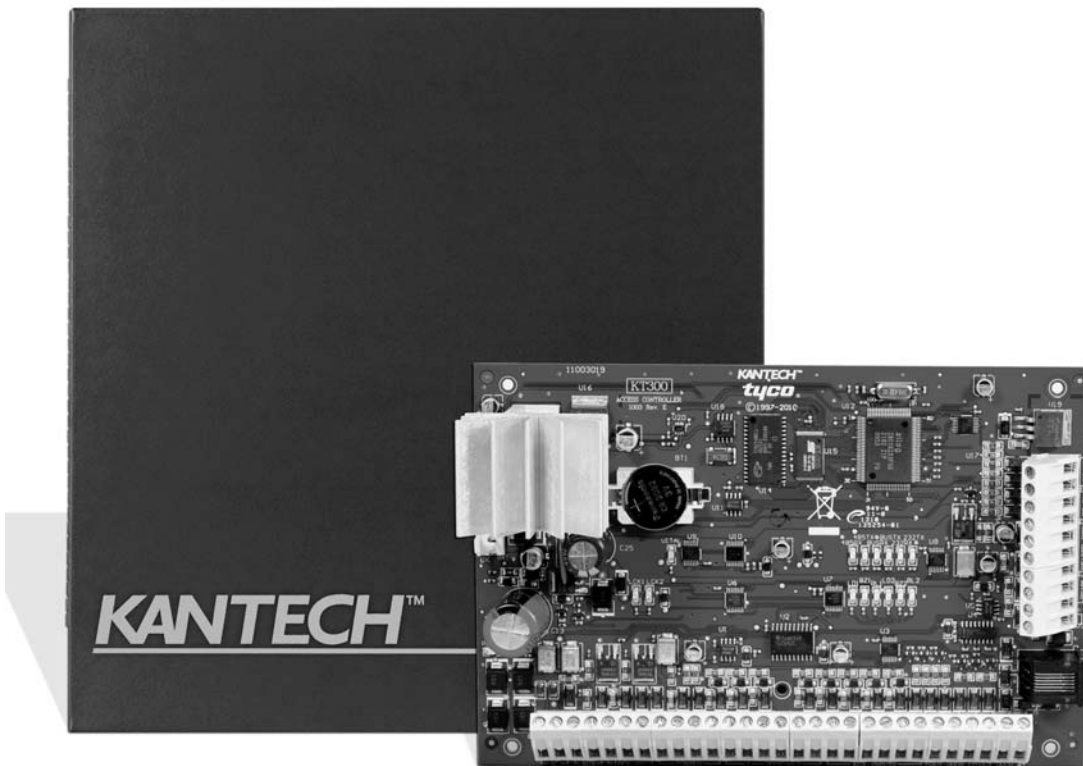

Installation Manual

**KANTECH**

DN1315-1007  
V01.02



# KT-300 Door Controller Installation Manual

## Table of Contents

Pre-Installation Information .....	1
Copyright Information .....	1
Safety Instructions .....	1
Components Required to Install KT-300 .....	1
Technical Support .....	1
KT-300 Compliance Specifications .....	2
FCC & IC Compliance .....	2
CE Compliance Notice .....	2
CE & C-Tick Compliance .....	2
UL Compliance Notice .....	2
UL 1076 Standard .....	2
Overview .....	3
Technical Specifications .....	4
Electrical Specifications .....	5
KT-300 Controller and Accessories .....	5
Installing the KT-300 .....	6
Physical Installation .....	6
Earth Grounding .....	6
Door Locking Devices .....	6
Hooking Up Inputs .....	7
Readers and Keypads .....	7
Relay Controlled Outputs .....	7
Auxiliary Outputs .....	8
Tamper Protection .....	8
Connecting the KT-300 .....	8
Connecting to the RS-485 Bus .....	8
Connecting the Master Controller to the Host PC .....	9
Powering the KT-300 .....	10
Installing Combus Modules .....	10
Introduction to Combus Modules .....	10
Combus Specifications .....	10
Combus Repower (If Required) .....	11
Module Housing Cabinet .....	11
KT-PC4108 - 8-Zone Input Expansion Module .....	12
KT-PC4108 Introduction .....	12
KT-PC4108 Specifications .....	12
Unpacking the KT-PC4108 Module .....	12
Mounting the KT-PC4108 Module .....	12
Installation and Wiring .....	12
Applying Power .....	12
Assigning the Module .....	12
KT-PC4204 - 4-Relay and Additional Power Supply Module .....	13
KT-PC4204 Introduction .....	13
KT-PC4204 Specifications .....	13
Unpacking the KT-PC4204 .....	13
Mounting the KT-PC4204 .....	13
Installation and Wiring .....	13
Applying Power .....	13
Assigning the KT-PC4204 Module .....	13
KT-PC4216 - 16-Zone Output Expansion Module .....	14
KT-PC4216 Introduction .....	14
KT-PC4216 Specifications .....	14
Unpacking the KT-PC4216 .....	14
Mounting the KT-PC4216 .....	14

# KANTECH

Installation and Wiring .....	14
Applying Power .....	15
Assigning the KT-PC4216 Module .....	15
KT3-LCD - Kantech LCD Time & Date Display Module .....	15
KT3-LCD Introduction .....	15
KT3-LCD Specifications .....	15
Unpacking the KT3-LCD .....	15
Mounting the KT3-LCD .....	15
Wiring the KT3-LCD .....	16
Applying Power .....	16
Assigning the KT3-LCD Keypad .....	16
Troubleshooting Communication Problems .....	16
Default Initialization .....	16
How to Use the Default Initialization (Hard Reset) .....	16
VITAL LED status indications .....	16
Visual Status Indicators (LEDs) .....	17
KT-300 Controller Maintenance Recommendations .....	18
KT-300 Wiring Diagram (North American Version) .....	19
KT-300 Wiring Diagram (UE Version) .....	20

## KANTECH WARRANTY TERMS

### For KANTECH Products Provided With or Without Components or Software

**KANTECH Products purchased with or without Components and Software is copyrighted and is purchased under the following limited warranty terms:**

Sensomatic Electronics, LLC ("Kantech") warrants the original purchaser that for a period of 5 years from the date of purchase, the product shall be free of defects in materials and workmanship under normal use. During the warranty period, Kantech shall, at its option, repair or replace any defective product upon return of the product to its factory, at no charge for labour and materials. Any replacement and/or repaired parts are warranted for the remainder of the original warranty period or ninety (90) days, whichever is longer. The original purchaser must promptly notify Kantech in writing that there is defect in material or workmanship, such written notice to be received in all events prior to expiration of the warranty period. There is absolutely no warranty on software, and all software products are sold as a user license under the terms of the software license agreement included with the product. The Customer assumes all responsibility for the proper selection, installation, operation and maintenance of any products purchased from KANTECH. Custom products are only warranted to the extent that they do not function upon delivery. In such cases, KANTECH can replace or credit at its option.

#### **International Warranty**

The warranty for international customers is the same as for any customer within Canada and the United States, with the exception that Kantech shall not be responsible for any customs fees, taxes, or VAT that may be due.

#### **Warranty Procedure**

To obtain service under this warranty, please return the item(s) in question to the point of purchase. All authorized distributors and dealers have a warranty program. Anyone returning goods to Kantech must first obtain an authorization number. Kantech will not accept any shipment whatsoever for which prior authorization has not been obtained.

#### **Conditions to Void Warranty**

This warranty applies only to defects in parts and workmanship relating to normal use. It does not cover any of the following, the occurrence of which will void this warranty:

- damage incurred in shipping or handling;
- damage caused by disaster such as fire, flood, wind, earthquake or lightning;
- damage due to causes beyond the control of Kantech, such as excessive voltage, mechanical shock or water damage;
- damage caused by unauthorized attachment, alterations, modifications or foreign objects;
- damage caused by peripherals (unless such peripherals were supplied by Kantech.);
- defects caused by failure to provide a suitable installation environment for the products;
- damage caused by use of the products for purposes other than those for which it was designed;
- damage from improper maintenance; and
- damage arising out of any other abuse, mishandling or improper application of the products.

#### **Items Not Covered by Warranty**

In addition to the items which void the Warranty, the following items shall not be covered by Warranty: (i) freight cost to the repair centre; (ii) products which are not identified with KANTECH's product label and lot number or serial number; (iii) products disassembled or repaired in such a manner as to adversely affect performance or prevent adequate inspection or testing to verify any warranty claim. Access cards or tags returned for replacement under warranty will be credited or replaced at KANTECH's option. Products not covered by this warranty, or otherwise out of warranty due to age, misuse, or damage shall be evaluated, and a repair estimate shall be provided. No repair work will be performed until a valid purchase order is received from the Customer and a Return Merchandise Authorization number (RMA) is issued by KANTECH's Customer Service. Kantech's liability for failure to repair the product under this warranty after a reasonable number of attempts will be limited to a replacement of the product, as the exclusive remedy for breach of warranty. Under no circumstances shall Kantech be liable for any special, incidental, or consequential damages based upon breach of warranty, breach of contract, negligence, strict liability, or any other legal theory. Such damages include,

# KANTECH

---

but are not limited to, loss of profits, loss of the product or any associated equipment, cost of capital, cost of substitute or replacement equipment, facilities or services, down time, purchaser's time, the claims of third parties, including customers, and injury to property. The laws of some jurisdictions limit or do not allow the disclaimer of consequential damages. If the laws of such a jurisdiction apply to any claim by or against KANTECH, the limitations and disclaimers contained here shall be applicable to the greatest extent permitted by law. Some states do not allow the exclusion or limitation of incidental or consequential damages, so that the above may not apply to you.

## **Disclaimer of Warranties**

This warranty contains the entire warranty and shall be in lieu of any and all other warranties, whether expressed or implied (including all implied warranties of merchantability or fitness for a particular purpose) and of all other obligations or liabilities on the part of Kantech. Kantech neither assumes responsibility for, nor authorizes any other person purporting to act on its behalf to modify or to change this warranty, nor to assume for it any other warranty or liability concerning this product. This disclaimer of warranties and limited warranty are governed by the laws of the state of New York.

## **WARNING:**

Kantech recommends that the entire system be completely tested on a regular basis. However, despite frequent testing, and due to, but not limited to, criminal tampering or electrical disruption, it is possible for this product to fail to perform as expected.

## **Out of Warranty Repairs**

Kantech will at its option repair or replace out-of-warranty products which are returned to its factory according to the following conditions. Anyone returning goods to Kantech must first obtain an authorization number. Kantech will not accept any shipment whatsoever for which prior authorization has not been obtained. Products which Kantech determines to be repairable will be repaired and returned. A set fee which Kantech has predetermined and which may be revised from time to time will be charged for each unit repaired. Products which Kantech determines not to be repairable will be replaced by the nearest equivalent product available at that time. The current market price of the replacement product will be charged for each replacement unit.

## **WARNING - PLEASE READ CAREFULLY**

### **Note to Installers**

This warning contains vital information. As the only individual in contact with system users, it is your responsibility to bring each item in this warning to the attention of the users of this system.

### **System Failures**

This system has been carefully designed to be as effective as possible. There are circumstances, however, involving fire, burglary, or other types of emergencies where it may not provide protection. Any access control system of any type may be compromised deliberately or may fail to operate as expected for a variety of reasons. Some but not all of these reasons may be:

- **Inadequate Installation**  
An access control system must be installed properly in order to provide adequate protection. Every installation should be evaluated by a security professional to ensure that all access points and areas are covered. Locks and latches on windows and doors must be secure and operate as intended. Windows, doors, walls, ceilings and other building materials must be of sufficient strength and construction to provide the level of protection expected. A reevaluation must be done during and after any construction activity.
- **Criminal Knowledge**  
This system contains security features which were known to be effective at the time of manufacture. It is possible for persons with criminal intent to develop techniques which reduce the effectiveness of these features. It is important that an access control system be reviewed periodically to ensure that its features remain effective and that it be updated or replaced if it is found that it does not provide the protection expected.
- **Access by Intruders**  
Intruders may enter through an unprotected access point, circumvent a sensing device, evade detection by moving through an area of insufficient coverage, disconnect a warning device, or interfere with or prevent the proper operation of the system.
- **Power Failure**  
Control units, readers, exit detectors and many other security devices require an adequate power supply for proper operation. If a device operates from batteries, it is possible for the batteries to fail. Even if the batteries have not failed, they must be charged, in good condition

and installed correctly. If a device operates only by AC power, any interruption, however brief, will render that device inoperative while it does not have power. Power interruptions of any length are often accompanied by voltage fluctuations which may damage electronic equipment such as an access control system. After a power interruption has occurred, immediately conduct a complete system test to ensure that the system operates as intended.

- **Motion Detectors - Request to Exit**

Motion detectors can only detect motion within the designated areas as shown in their respective installation instructions. Motion detectors do not provide volumetric area protection. They have multiple beams of detection and motion can only be detected in unobstructed areas covered by these beams. They cannot detect motion which occurs behind walls, ceilings, floor, closed doors, glass partitions, glass doors or windows. Any type of tampering whether intentional or unintentional such as masking, painting, or spraying of any material on the lenses, mirrors, windows or any other part of the detection system will impair its proper operation. Passive infrared motion detectors operate by sensing changes in temperature. However their effectiveness can be reduced when the ambient temperature rises near or above body temperature or if there are intentional or unintentional sources of heat in or near the detection area. Some of these heat sources could be heaters, radiators, stoves, barbeques, fireplaces, sunlight, steam vents, lighting and so on.

- **Component Failure**

Although every effort has been made to make this system as reliable as possible, the system may fail to function as intended due to the failure of a component.

- **Inadequate Testing**

Most problems that would prevent a system from operating as intended can be found by regular testing and maintenance. The complete system should be tested weekly and immediately after a break-in, an attempted break-in, a fire, a storm, an earthquake, an accident, or any kind of construction activity inside or outside the premises. The testing should include all sensing devices, keypads, consoles, alarm indicating devices and any other operational devices that are part of the system.

---

## Pre-Installation Information

**To the Installer:** If you are familiar with the installation, you can use the checklist with the ☒ symbol.

### Copyright Information

Copyright © 2010 Tyco International Ltd. and its Respective Companies. All Rights Reserved. All specifications were current as of publication date and are subject to change without notice. EntraPass, Kantech and the Kantech logo are trademarks of Tyco International Ltd. and its Respective Companies.

---

### Safety Instructions

ONLY SERVICE PERSONS WILL INSTALL AND MAINTAIN THE KT-300. Service persons must have appropriate technical training and experience necessary to be aware of the hazards to which they are exposed and of measures to minimize the danger to themselves or other persons.

The connection to the mains supply must be made as per local authorities rules and regulations: in the UK as per BS6701.

Provide an appropriate disconnect device, as part of the building installation. Where it is not possible to rely on the identification of the NEUTRAL in the AC MAINS SUPPLY, the disconnecting device must disconnect both poles simultaneously (LINE and NEUTRAL).

If a knockout is removed during installation, it is the installer's responsibility to ensure that the same degree of protection is provided for the cabinet by the use of bushings, fittings, etc.

Secure the metal cabinet to the building structure before operation.

Internal wiring must be routed in a manner that prevents:

- Excessive strain on wire and on terminal connections;
- Loosening of terminal connections;
- Damage of conductor insulation.

The power supply must:

- Be permanently connected, fail safe, with double or reinforced insulation between primary and secondary circuits.
- In EU countries it must meet the applicable requirements of the *Low Voltage Directive* and protected as per EN60950-1:2006 requirements.
- In other countries, it must be of approved type acceptable to local authorities.

The screwdriver supplied within the ACCESSORY KIT for KT-300 must NOT BE USED in ANY ELECTRICAL CIRCUIT that exceeds the SELV limits: e.g.: 30 V rms or 60V DC under normal operating conditions; DO NOT USE the supplied screwdriver for ANY MAIN CONNECTIONS to the TERMINAL BLOCK.

The SUPPLIED screwdriver is designated for SERVICE PERSONS ONLY and shall not be left with the OPERATOR of the system.

The ground connection must be provided via the TERMINAL BLOCK at the PE (IEC 60417-5019 symbol) marked connection.

It is the end-user and/or installer's responsibility to ensure that the disposal of the used batteries is made according to the waste recovery and recycling regulations currently applicable.

---

### ☒ Components Required to Install KT-300

- KT-300 Controller with accessory kit
- AC transformer 120 V/16 VAC, 40 VA, class 2 for the KT-300 N.A. model
- AC transformer 230 V/16 VAC, 100 VA, fused (included in the KT-300 EU model)
- One 12 volt battery 7 A/h\*
- Ground clamp\*

A visual inspection should be made when unpacking the KT-300. Any missing item/part or damaged component should be reported immediately.

\*Not included

---

### Technical Support

For technical assistance with the KT-300 and other Kantech products, contact technical support, Monday to Friday 8:00 AM to 8:00 PM (GMT -5:00)

- **Toll-Free phone (US & Canada):** 1 (888) 222-1560
  - **Phone:** +1 (450) 444-2030
  - **Fax:** +1 (450) 444-2029
  - **Internet:** www.kantech.com
  - **E-mail:** kantechsupport@tycoint.com
-



## KT-300 Compliance Specifications

### FCC & IC Compliance

This device complies with FCC Part 15, Subpart B:2009. Operation is subject to the following two conditions: (1) this device may not cause harmful interference, and (2) this device must accept any interference received including interference that may cause undesired operation. This class B digital apparatus meets all requirements of the Canadian Interference Causing Equipment Regulations. The KT-300 is also compliant with EN55022:2006, Class B.

---

### Compliance Notice

This product is in conformity with EMC Directive 2004/108/EC based on results using harmonized standards in accordance with article 10(5) and LVD Directive 2006/95/EC based on results using harmonized standards. This product is labeled with CE mark as proof of compliance with the above mentioned European Directives.

---

### CE & C-Tick Compliance

- EN50133-1: Alarm systems - Access control systems for use in security applications: system requirements.
- 

### UL Compliance Notice

To comply with UL listings, the following requirements must be met:

- Use of a UL listed computer
- Use of UL listed readers (Wiegand 26 and 34 bits, mag stripe 26 and 34 bits, have been tested and found to comply)
- Use of a UL recognized tamper switch on every housing cabinet for the KT-300
- Do not use the SmartLink option
- Use the Kantech IP Link Enhanced Ethernet Device
- Use the KT3-LCD module on each KT-300 controller (should be installed near the controller)
- Do not use a 220 V transformer (not UL listed)
- Use only UL listed cables
- Use only UL listed adaptors
- Use only a UL listed transformer such as Kantech TR1640P/UL or DSC PRD1640
- Use Kantech BD7-12 battery
- The KT-CAB3000LDR and KT-CAB4000LDR have been evaluated by UL as alternate enclosures.

NOTE: Backup battery provides operation of up to 12 hours but has been tested only 4 hours per Section 33 of UL294, fifth edition.

NOTE: All circuits are power limited.

---

### UL 1076 Standard:

The following Kantech readers were validated by UL for the UL 1076 standard: P225W26, P225KPW26, P225KPXSF, P225XSF, P325W26, P325KPW26, P325XSF, P325KPXSF, and P600.

## Overview

The KT-300 will operate with the EntraPass software

### Innovative and Powerful

The Kantech KT-300 Door Controller is designed to meet the highest standards of access control and point monitoring applications.

### Downloadable Firmware

The firmware program, stored in the controller's flash memory, is updated without changing the memory chips. The firmware program can be uploaded from any EntraPass workstation.

### Speed selection - Fast! Up to 115,200 Bauds

The KT-300 automatically detects the site communication speed set by EntraPass.

### Trouble and Reporting

The KT-300 constantly supervises battery condition and reports "Low battery" or "No battery" status to the EntraPass system. Power outputs are supervised and individually protected against short-circuits and surges by self-resetting PTC. Locking devices are also supervised for short and open circuits.

### Built-in Combus Expansion

The KT-300 supports expansion modules to add inputs, outputs and an LCD time and date display for Time & Attendance purposes.



**KT-PC4108 - 8-Zone Input Expansion Module**

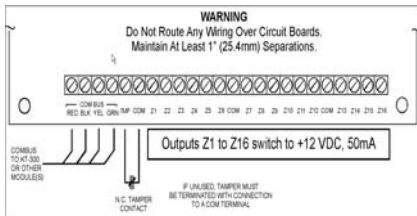

**KT-PC4216 - 16-Output Expansion Module**

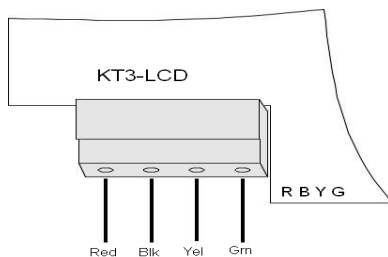

**KT-3LCD-LCD Time and Date Display for Time & Attendance**

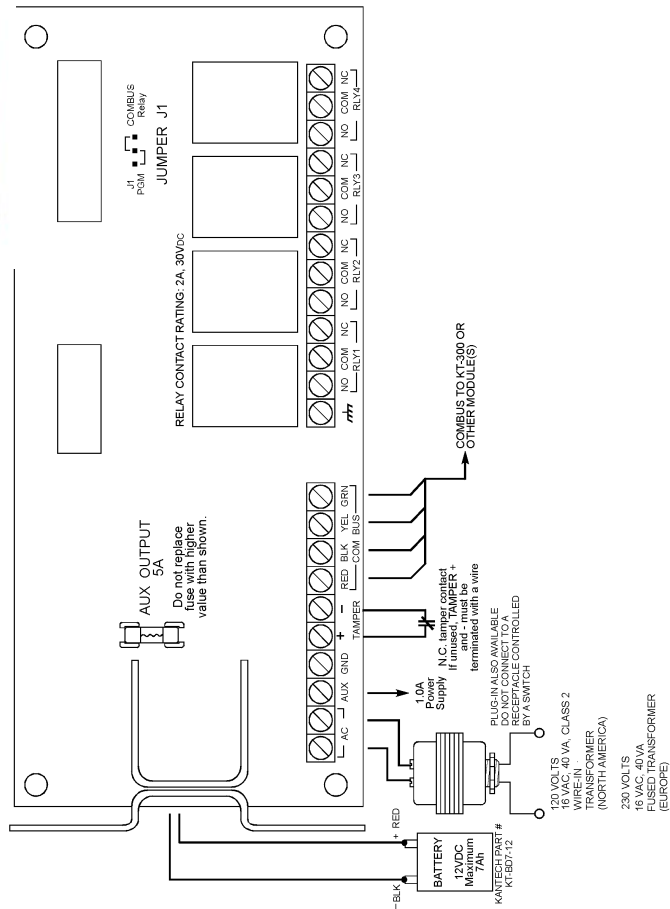

**KT-PC4204 - 4-Relay and Combus Additional Power Supply Module**

## Technical Specifications

Specification	Description
AC Power Input	120/16VAC, 40VA, class 2 transformer (North America) 230/16VAC, 100VA, fused transformer (Europe)
Battery Back-up	1battery 12VDC, 7Ah, supervised, provides up to 12 hours of operation, Kantech BD7-12 battery tested for 4 hours standby for UL294
Operating Temperatures	From 2°C to 40°C (35°F to 110°F)
Cabinet Dimensions (H-W-D)	29.9 cm x 28.8 cm x 7.7 cm (11-3/4" x 11-3/8" x 3") EMT 1.9 cm (3/4") (North American model) 33.5 cm x 35 cm x 8 cm (13" x 13-3/4" x 3") (European model)
Cabinet Weight	2.4 kg (5.4 lbs) North American model 5.6 kg (12.4 lbs) European model
PCB Dimension	18.3 cm x 12.18 cm x 5.20 cm (7-1/4" x 4-3/4" x 2-1/16")
Reader Types	Wiegand, proximity, bar code, magnetic, integrated keypad and others
Reader Power Output	12 VDC and 5VDC @ 175mA max, protected and supervised
Monitored Points	8 monitored points, NO/NC, w/without EOL's (expandable to 16), use UL recognized tamper switch on cabinet housing to conform with UL 294
Points Maximum Wiring	AWG #22 - 600 meters (2,000 feet)
Door Strike Power	12 V DC, 250mA max each, supervised
Auxiliary Outputs	4 outputs, 25mA max each, open collector
Relay Controlled Output	2-relay controlled outputs, 25mA max each. Open collector to ground (use form "C" relays Kantech #KT-RM1 if needed)
Auxiliary Power Output	11.5 to 13.85 VDC @ 175mA max, protected and supervised
Communication Ports	RS-232, RS-485 and Combus
Communication Speed	Up to 115.200 baud (automatic detection)
Firmware Flash Memory	256K
RAM Memory	512K; protected by a lithium battery
Network Autonomy	Distributed data and processing
Certifications / Listing	CE, FCC, UL294 listed

## Electrical Specifications

VOLTAGE OUTPUTS	MAXIMUM CURRENT (N.A.)	MAXIMUM CURRENT (EU)	ABSOLUTE COMBINED MAXIMUM (N.A.)	ABSOLUTE COMBINED MAXIMUM (EU)
Lock Outputs (12 VDC)	500 mA (250 mA each)	1.0 A (500 mA each)		
Auxiliary Power (11.5 to 13.85 VDC)	175 mA	175 mA		
Reader 5 VDC and 12 VDC	175 mA	175 mA		
Combus	500 mA	500 mA		
Battery Charging (12 VDC)	250 mA	250 mA	1.5 A	2.0 A
<b>OPEN COLLECTOR OUTPUTS</b>	<b>MAXIMUM CURRENT</b>			
LED (Door 1 & 2)	25 mA (each)	25 mA (each)		
Buzzer (Buz, Door 1 & 2)	25 mA (each)	25 mA (each)		
Controlled Relay 1 & 2 (RL1 & RL2)	25 mA (each)	25 mA (each)		

## KT-300 Controller and Accessories

Kantech Model	Description
KT-300/512K	Door controller with 512K memory including KT-300CAB, KT-300ACC and KT-LOCK
KT-300PCB/512	KT-300/512K PCB only and KT-300 ACC (not UL listed)
KT-300ACC	Accessory kit including: 2 X 1.0k ohm, 10 x 5.6k ohm, 2 x 120 ohm, PCB standoffs, lock hole cover, ground wire and screwdriver
KT-PC4108	8-zone input expansion module for KT-300
KT-PC4204	4-Relay and Combus additional power supply module for KT-300
KT-PC4216	16-Output expansion module for KT-300
KT-RM1	External isolation relay SPDT for KT-300 output (RL1/RL2) (not UL listed)
KT3-LCD	Time & date LCD display unit for KT-300
KT-300CAB	KT-300 black metal cabinet including KT- LOCK
KT-4051CAB	Standard black metal cabinet for KT-PCxxx modules (order keylock separately)
KT-LOCK	Keylock for KT-300CAB/KT-4051CAB metal cabinet (2keys/same as KT-200)
KT-TAMP	Tamper switch for KT-300CAB/KT-4051CAB metal cabinet
TR1637W/CSA	Transformer, Wire-in, 110V/16V (37VA) CSA (not UL listed)
TR1640P/CSA	Transformer, Plug-in, 110V/16V (40VA) CSA (not UL listed)
TR1640P/UL	Transformer, Plug-in, 110V/16V (40VA) UL or DSC PTD1640 <a href="http://www.dsc.com">www.dsc.com</a>
TR1640W-220	Transformer, Wire-in, 230V/16V (40VA) CE (not UL listed)

<b>Kantech Model</b>	<b>Description</b>
VC-485 or USB-485	Multi-function communication interface

## Installing the KT-300

### Physical Installation

Check for ideal indoor location.

Stay away from electrical or communication devices.

The KT-300 Controller cabinet has been designed to be mounted on a wall without any additional enclosures. The cabinet is large enough to accommodate the battery backup supply and the necessary wiring connections for most applications. EMT (Electrical Metallic Tubing) conduit knockouts are provided in 2.2 cm (7/8") on all sides of the cabinet.

The cabinet should be mounted indoors, in a secure location providing normal temperature and humidity, leaving 23 cm (8") clear space around all sides and a minimum of 33 cm (13") clear space in front of the cabinet. The location should be easily accessible for servicing the equipment and it is recommended that controllers be located close to the controlled doors.

Controllers must be located at a minimum distance of 2 m (6 feet) from any high voltage equipment or wiring and from electrical equipment susceptible of generating electrical interference, at a minimum distance of 1 m (3 feet) from telephone equipment or lines, and at a minimum of 8 m (25 feet) from any transmitting equipment.

Physical access, using keys, on controlled doors must be provided so that the KT-300 can easily be accessed for servicing in case of malfunction.

### Earth Grounding

AWG#18 grounding wire to EGND.

The KT-300 uses high performance communication, proper grounding must be provided to ensure proper operation.

Make an earth ground connection to the cabinet of the KT-300 as per the requirements of your local electrical code. Wire the E-GND terminal on the KT-300 printed circuit board directly to that connection point.

### Door Locking Devices

Connect door locks to + and LK1- (+ and L2-)

Maximum 250mA @ 12 VDC per output

Check for local "magnetic lock" regulations

LK1-, LK2- and + terminals are located on the bottom left to the KT-300 terminal strip. The locking device outputs are controlled according to the end-user programmed parameters for allowing access to or unlocking doors according to schedules and access levels. These door locking device outputs can operate DC powered locking devices such as electromechanical strikes and can be configured to operate fail-safe or fail-secure (normal or reverse action). Maximum DC current for each lock output is 250 mA.

**NOTE:** Use 1K ohm EOL (End-Of-Line resistor) between + and LK- if not used. This resistor is already included within the controller packaged box (KT-300ACC).

**WARNING:** Controlled door locks may be governed by regulatory bodies and should always be installed according to local regulations. In most instances, there are strict limitations to installing fail-secure devices and fail-safe locking devices such as magnetic locks or other similar locking devices on doors used as emergency exits.

*This equipment is designed to be used in an environment that meets a maximum pollution degree of 2 and over voltages category II - NON HAZARDOUS LOCATIONS, indoor only. The equipment is FIXED and PERMANENTLY CONNECTED. It must be installed in a metal cabinet by service persons only. Service person is defined as: Persons having the appropriate technical training and experience necessary to be aware of hazards to which they are exposed in performing a task and of measures to minimize the risks to that person or other persons.*

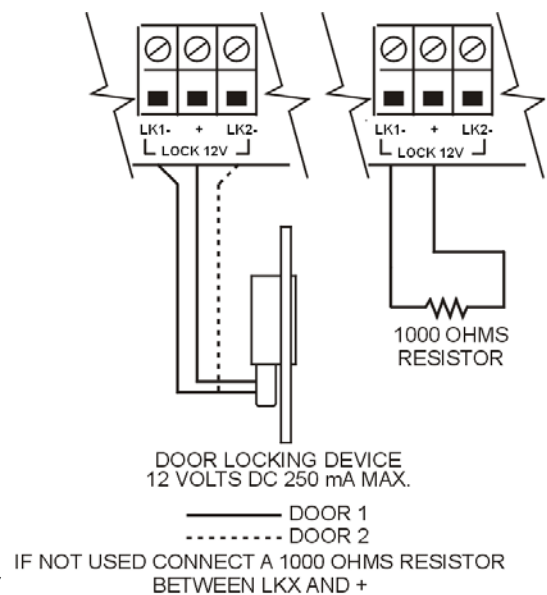

### Hooking Up Inputs

Connect devices to inputs 1 to 8.

Resistors (included with KT-300) for all inputs 5.6K ohm (if selected).

The KT-300 has an on-board capability of monitoring 8 input points (expandable to 16 if KT-PC4108 module is used). Each input is supervised with or without end-of-line resistors (5.6K ohm). The maximum distance of one line is 600m (2,000 feet) with AWG#22.

NOTE: Inputs can be defined with: none or one EOL (End-Of-Line) resistor according to your EntraPass software settings.

Inputs 1-2 are automatically reserved for the first controlled door. The contact is assigned input 1 and the associated request-to-exit detector as input 2. Inputs 3 and 4 are automatically reserved for the second controlled door. The contact is assigned input 3 and the associated request-to-exit detector as input 4. There is no obligation to follow these rules but this standard convention facilitates servicing.

Door 1 contact connection

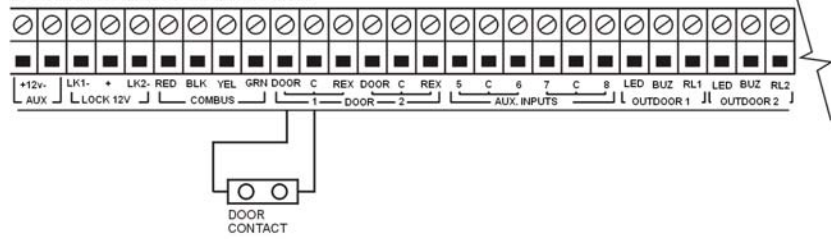

Door 1 T.Rex connection

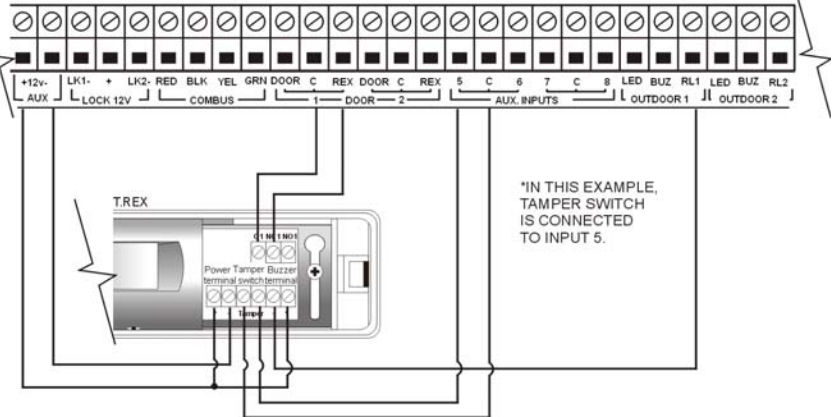

### Readers and Keypads

#### READER CONNECTION TERMINAL WARNING

Connection the red wire lead (or power lead) of a 5 VDC reader to the 12 VDC terminal may damage the reader. See your reader installation procedure for proper power connection.

Up to 2 readers can be connected to a KT-300. They can be installed on one door to control both entry and exit or on two separate doors operating independently to control one-way access.

The distance between the readers and the KT-300 controller varies by reader type (please consult the installation manual for details). Auxiliary outputs provide visual and/or audible access operation feedback at the controlled door. Outputs “OUT DOOR 1 LED & BUZ” are used for the first door and “OUT DOOR 2 LED & BUZ” are used for the second door.

The 12 VDC auxiliary power can also be used to power low current audible devices usually located at the controlled door.

### Relay Controlled Outputs

Connect controlled outputs to low voltage devices (25 mA max).

Add external relays for high voltage devices (optional - Kantech # KT-RM1).

The KT-300 provides two controlled outputs - RL1 & RL2 (open collector to ground-current limited to 25 mA). Use a KT-RM1 (optional) to switch larger currents or voltages or to supply a dry contact.

When activated, relay 1 and 2 (RL1 and RL2 LED) outputs provide visual feedback of their active status, as shown in Figure X. Can be expanded up to 16 controlled outputs when using a KT-PC4216 module. This module allows a maximum of 16 outputs and a maximum of up to 50 mA per output. Since the KT-300 only supports 500 mA, a power supply module can be used to provide an additional 1 A to the Combust.

NOTE: If you are using a KT-PC4204 in “repower” mode and other KT-PC4216 modules that are assigned as relays 1-16 also connected to the same loop, do not use relay 1 of those modules or relay 1 of the KT-300 Door Controller (see the *Combust Repower* section for more information).

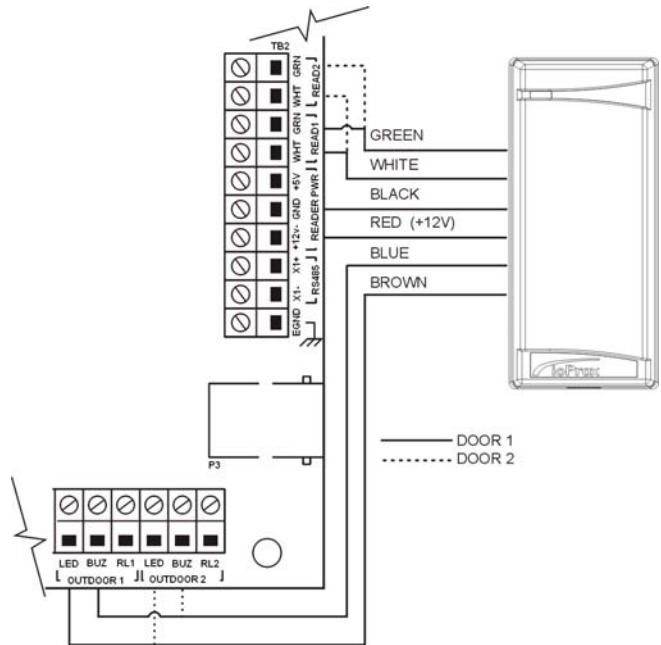

## Auxiliary Outputs

### Connect auxiliary outputs to readers and local warning devices.

Auxiliary outputs are used for visual and audible signals. They can be activated according to schedules, input conditions or events and local alarms. Auxiliary outputs "OUT DOOR 1 & 2 LED" provide visual feedback of access operation, and auxiliary outputs "OUT DOOR 1 & 2 BUZ" can activate audible warning devices, such as T-REX, to signal door alarms.

## Tamper Protection

### Install tamper switch on cabinet (Kantech #KT-TAMP).

A tamper switch must be installed on the unit to detect unauthorized cabinet opening.

The normally closed tamper switch is connected to an input (choose an unused input (5 to 8) as tamper input or any other unused inputs on the KT-PC4108 module (if used)).

NOTE: The tamper switch is required for a UL listed installation.

---

## Connecting the KT-300

### Connecting to the RS-485 Bus

#### Connect RS-485 cable to X1+, X1- and GND.

Controllers are linked together through their RS-485 connectors. The maximum communication loop length is 1.2 kilometers (4,000 feet) using appropriate cabling. Connecting several KT-300 controllers at a single point is not acceptable nor are splitters or "spider web networks."

The RS-485 communication loop should be wired with Ethernet Category 3 double twisted pair network cable (see cable specifications Belden 1227A, or equivalent). The RS-485 loop can operate from 1,200 to 115,200 bauds under normal conditions.

Intermittent communication problems or erratic operation may require network speed drops to 9,600 or 19,200 Bauds. Varying the network speed does not perceptibly change the operation speed of the system. Usually, most installations should be set to 19,200 Bauds.

NOTE: To learn more about USB-485 wiring, please refer to the *USB-485 Installation Sheet*, DN1482.



**Connecting the Master Controller to the Host PC**

**Connect flat cable from KT-300 to the PC.**

**From 0 to 30m (0 to 100 feet):**

If the local master controller is located less than 30m (100 feet) from the host computer, use the on-board RS-232 RJ12 jack and the supplied flat cable.

**NOTE:** If you plan to locate the host PC more than 30m (100 feet) away from the controller, be sure to use a VC-485 interface. Otherwise, reduce the communication speed to a minimum to avoid data loss.

**From 30m to 1.2 km (100 to 4,000 feet)**

If the master controller is located more than 60m (200 feet), an optional VC-485 multi-function communication interface must be used. It can also be used when running a communication cable in areas unusually high in electrical noise.

**NOTE:** The host computer is used to program the KT-300 Controllers.

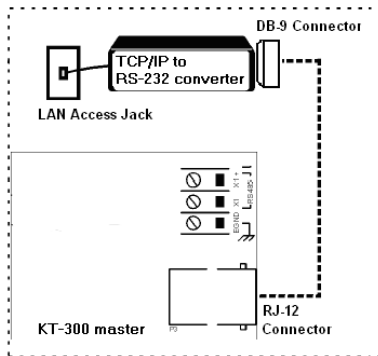
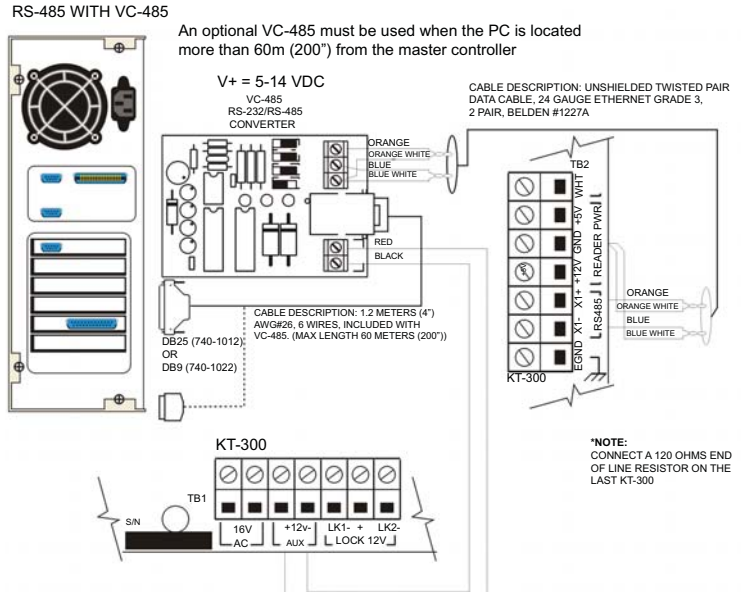
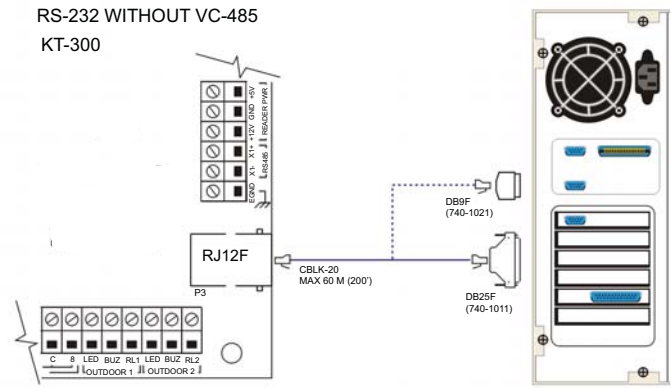

**Over Corporate Network (LAN)**

If the master controller is used in a LAN-enabled corporate setting, use TCP/IP-to-RS-232 converter (such as the Kantech IP Link or the Lantronix UDS-1100 communication interface) to connect the controller to the corporate network. This method uses existing wiring for data exchange between EntraPass and the controllers. The diagram on the left shows how to connect a DB-9 to RJ-12 flat cable between the master controller and the converter. Consult *Application Note DN1506* to learn how to set up the communication interface.

**For remote sites**

If the master controller is used in remote areas, modems must be used to send and receive access control data over telephone lines. For this application Kantech supports US Robotics 56K external Sportster modems at both ends of the communication line. As shown on the right, a modem connects to the master controller only using a DB25 to RJ-12 flat cable. For dial-up communication settings via software, refer to your communication settings.

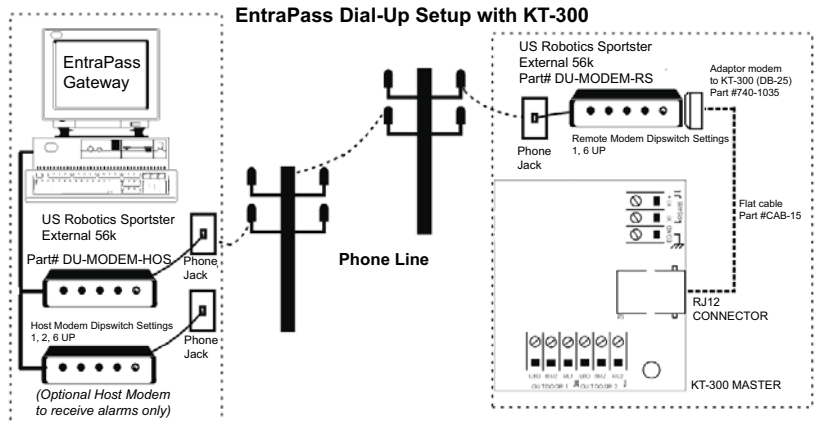

## Powering the KT-300

- ☒ Install 120 V / 16VAC, 40 VA, class 2 transformer (North Am.).
- ☒ Connect 230 V / 16VAC, 100 VA, fused transformer (Eur.)
- ☒ Place battery in cabinet.
- ☒ Power the KT-300 controller.

The KT-300 Controller must be powered by a 16VAC/40VA class 2 wire-in or plug-in transformer (applicable to the North American model). The KT-300 European controller must be powered by a 16VAC/100VA fused transformer.

After you have completed all the necessary steps, you may power the KT-300 Controller. Connect AC power as well as the battery. Once powered, check the VITAL LED status indicator to determine the status of communication and other vital parameters. Consult the troubleshooting section for VITAL LED behavior identification.

If the AC supply is removed, the 12 Volt 7 A/h led-type backup battery will support normal operation for up to 12 hours if fully charged. Internal battery verification will cutoff battery power if the battery voltage level falls below 9.5 Volts.

NOTE: The KT-300 Controller will not start on battery alone.

NOTE: Power should only be applied to the unit when all connections are completed and tested.

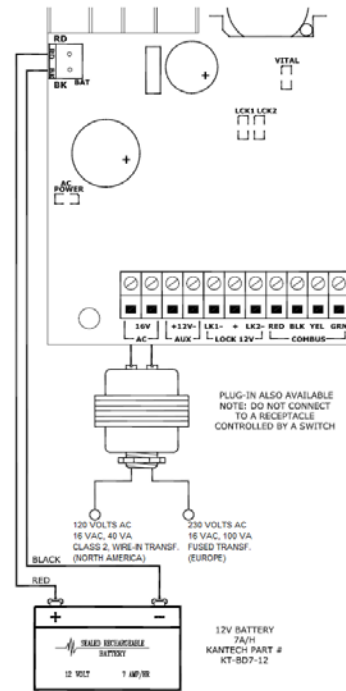

## Installing Combos Modules

### Introduction to Combos Modules

The Combos terminals on the KT-300 Controller are used to connect expansion modules to add inputs, outputs, relays and LCD time and date display. The four Combos terminals of the main panel must be connected to the four Combos terminals or wires of all modules.

Four expansion modules can be connected to KT-300's Combos (more specifications on each of these modules can be found later on in this document.):

- KT-PC4108 - 8-Zone input expansion module
- KT-PC4204 - 4-Relay/Power supply expansion module
- KT-PC4216 - 16-Zone output expansion module
- KT3-LCD - Kantech LCD keypad module

### Combos Specifications

The Combos provides 500 mA at 12 Volts (13.85 VDC). The recommended cable is #22 AWG. Each loop (module to KT-300) cannot exceed 300 m (1,000 feet) and the total maximum cable length of all connected loops cannot exceed 1,200 m (4,000 feet).

For example:

- Only four wireruns at 1,000 feet from the KT-300.
- Only eight wireruns at 500 feet from the KT-300.
- Only ten wireruns at 400 feet from the KT-300

Shielded wire should only be used in areas with excessive RF noise of electromagnetic interference. Modules can be straight run, connected in a daisy chain or T-tapped anywhere on the Combos.

Keep in mind that the new modules must be defined in the EntraPass system when they are added to the Combos. Refer to the *Controller Definition* section in the *EntraPass Reference Manual* to learn how to assign modules to your system.

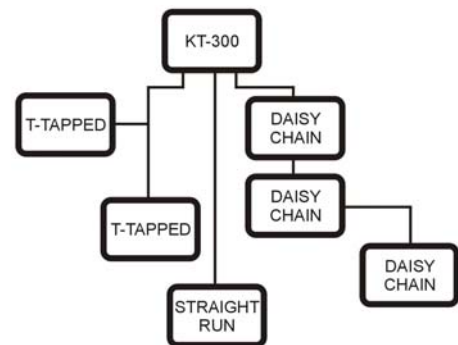

**Combus Repower (If Required)**

Depending on how many modules are connected to the Combus and how far they are from the KT-300 controller, you may need to “repower” the controller’s Combus.

The Combus needs to be “repowered” if the voltage drops below 12.5 Volts between black and red wires of the last module of each loop (the modules will still operate but there will be no communication between the modules and the controller and a “Combus module defect” event will be generated from the controller). This voltage drops if modules are drawing too much current (500mA maximum for the Combus of each KT-300).

Verify this voltage with a multi meter, and determine if you need to install a KT-PC4204 in “repower” mode. Using this configuration, you will be provided with an additional 1 amp of current on the controller’s Combus. The KT-PC4204 is generally installed at the beginning of the loop.

When using the KT-PC4204 in “repower” mode, the first relay of the module will be reserved for the “repower function”. You will have to assign an “all valid” schedule to the first relay so it is “always activated” (refer to the Controller definition section of your *EntraPass User Reference Manual* for the exact procedure.)

If you are using a KT-PC4204 in “repower” mode and other KT-PC4204 modules that are assigned as relays 1-4 or KT-PC4216 modules that are assigned as relays 1-16 are also connected to the same loop, do not use relay 1 of those modules or relay 1 of the KT-300 door controller. Please also note that all KT-PC4204 modules that are used for Combus repower should be assigned as relays 1-4.

**NOTE:** Jumper 1 “J1” on the KT-PC4204 must be moved to the Combus relay position.

**NOTE:** Do not use any power supply other than the KT-PC4204 to repower the Combus. In the event of a power surge or transient, a module may lock up and cease to communicate with the controller. If the KT-300 loses communication with the module, it will initiate a module reset and will power down the Combus for five seconds in an attempt to reset the problem module. After five seconds, the controller will reapply power to the Combus and the problem module should begin to operate as intended.

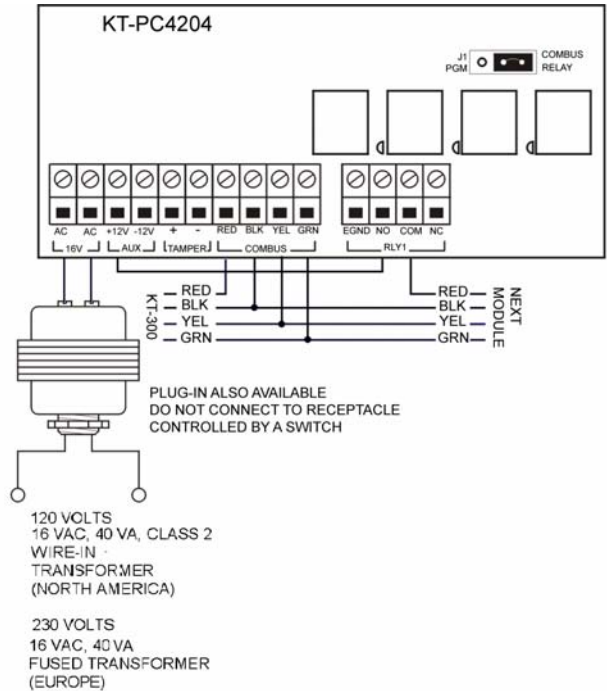

**Module Housing Cabinet**

**Kantech Part:** KT-4051CAB

**Measurement:** 16.8” H x 10.4” W 4.1” D (42,5cm H x 26.4 cm W x 10.4 cm D)

**Color:** Black

**Cabinet will hold either:**

- One KT-PC4204 power supply/relay module with batteries
- Three KT-PC4216/KT-PC4108 modules
- Up to six (6) KT-PC4108A/KT-PC4216 modules, mountable on both sides of the cabinet (three modules on each side)

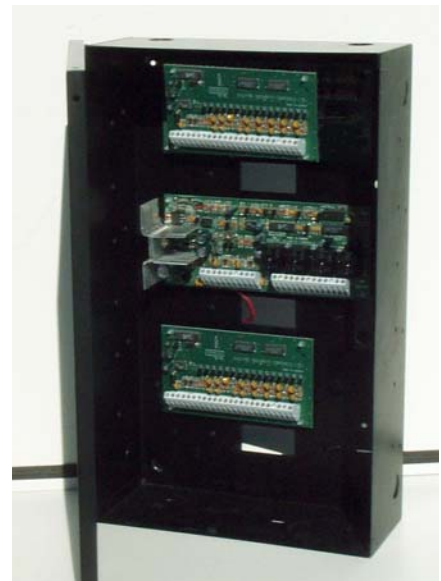

## KT-PC4108 Input Module

### KT-PC4108 Introduction

The KT-PC4108 module is a zone input module that adds up to 8 fully programmable zones to the KT-300 Controller.

### KT-PC4108 Specifications

- Connects to the controller via 4-wire Combus
- Current draw: 30 mA (from Combus)
- Supports single end-of-line and no end-of-line (5600 ohm resistors) zone loops
- AUX+ output: 12 VDC, 250 mA max. (drawn from Combus)
- Tamper contact input
- UL listed

### Unpacking the KT-PC4108 Module

The KT-PC4108 package includes the following parts/items:

- One KT-PC4108 circuit board - 9.2 cm x 3.3 cm (3<sup>5/8</sup>" x 1<sup>1/4</sup>"
- 16 end-of-line resistors (5600 ohms)
- Three (3) plastic standoffs with adhesive
- One (1) installation instructions sheet

### Mounting the KT-PC4108 Module

The KT-PC4108 module should be located inside a compatible cabinet (Kantech part no. KT-4105 CAB), mounted in a dry, secure location. Preferably, it should be placed at a convenient distance from the connected devices.

Perform the following steps to mount the unit:

1. Press the three (3) plastic standoffs through the mounting holes on either side of the cabinet.
2. Secure the cabinet to the wall in the desired location. Use appropriate wall anchors when securing the cabinet to drywall, plaster, concrete, brick or any other surfaces.
3. Press the circuit board into the three (3) plastic standoffs to secure the unit to the cabinet.
4. Remove the protective film from the plastic standoffs and attach the circuit board to the cabinet.

NOTE: Wiring may take place once the unit is mounted.

### Installation and Wiring

Before wiring the unit, ensure that all power sources (AC transformer and battery) are disconnected from the controller. Perform the following steps to complete wiring:

1. Connect the four Combus wires to the KT-PC4108. Connect the Red, Black, Yellow and Green Combus wires to the RED, BLK, YEL and GRN terminals, respectively.
2. Complete all zone wiring to the zone input terminals (Z1-Z8).
3. Connect the external tamper switch, if used.

NOTE: Consult the wiring diagram above for further information.

### Applying Power

After wiring is completed, apply power to the controller. Connect the battery leads to the battery, then connect the AC transformer.

NOTE: Do not connect the power until all wiring is completed.

### Assigning the Module

Once all wiring is completed, the module must be assigned to the system. To assign the module, perform the following steps:

1. Establish communication between EntraPass and the controller.
2. Remove the tamper switch wire (or only the wire if tamper switch is not used). If there is no connection to the TAM input, use the **Tamper Switch** button to generate an event.
3. An event will be displayed on the EntraPass workstation Desktop Message screen, indicating the module's serial number, type and the controller to which it is connected.
4. From the software, select the functionality of the module and enter the serial number in the appropriate field (see your software reference manual under controller definition -- Assigning modules for more details).

NOTE: Do not forget to reconnect the tamper switch (or the wire, if there is no tamper switch).

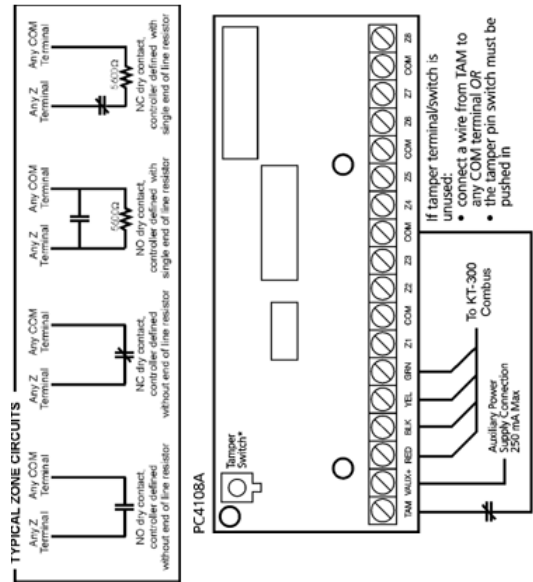

## KT-PC4204 - 4-Relay and Additional Power Supply Module

### KT-PC4204 Introduction

The KT-PC4204 module is an output module with four programmable relays. This module can be used to “repower” the Combus. The KT-PC4204 can also be used for elevator control.

**NOTE:** Do not use any power supply other than the KT-PC4204 module to repower the Combus. If a power supply other than the KT-PC4204 is used, the Combus repower function will not operate as intended.

### KT-PC4204 Specifications

- Current draw: 30 mA (from Combus)
- 40 VA 16 VAC transformer required
- Maximum 7 A/h battery required
- Connects to the controller via 4-wire Combus
- Four programmable relay contacts rated 2 A, 30 VDC
- AUX current: 1.0 A max.
- Tamper contact input
- Can be used to repower the Combus

### Unpacking the KT-PC4204

The KT-PC4204 package should include the following parts/items:

- One KT-PC4204 circuit board
- One ground wire assembly
- Five plastic standoffs
- One 5 A replacement fuse

### Mounting the KT-PC4204

The KT-PC4204 should be located inside a compatible cabinet (Kantech part no. KT-4051CAB), mounted in a dry, secure location. Preferably, it should be placed at a convenient distance from the connected devices. Perform the following steps to mount the unit:

1. Push the five plastic standoffs through the mounting holes on the back of the cabinet.
2. Secure the cabinet to the wall in the desired location. Use appropriate wall anchors when securing the cabinet to dry wall, plaster, concrete, brick or other surfaces.
3. Press the circuit board into the plastic standoffs to secure the module to the cabinet.

**NOTE:** Wiring may take place once the unit is mounted.

### Installation and Wiring

Before wiring the unit, ensure that all power (AC transformer and battery) is disconnected from the KT-300 controller. Perform the following steps to complete wiring:

1. Connect the four Combus wires to the KT-PC4204. Connect the red, black, yellow and green Combus wires to the RED, BLK, YEL and GRN terminal respectively.
2. If the module is used for Combus Repower, connect the Combus wires according to the diagram on the right. Note that for this option, Jumper J1 must also be set to “Combus Relay”.
3. Complete all output wiring.
4. Connect the external tamper switch, if used.

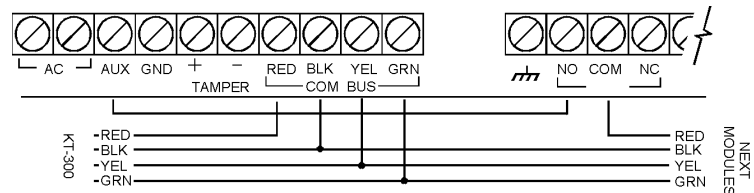

### Applying Power

After wiring is completed, apply power to the KT-300. Connect the battery leads to the battery, and connect the AC transformer. Then, connect power to the KT-PC4204; the battery leads followed by the AC transformer.

**NOTE:** Do not connect the power until all wiring is complete.

### Assigning the KT-PC4204 Module

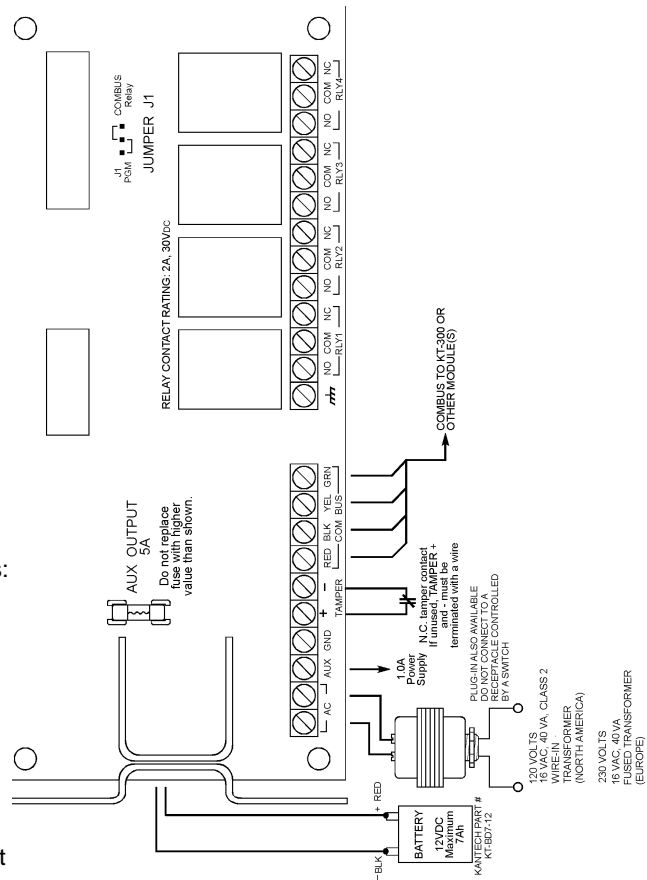



Once wiring is completed, the module must be assigned to the system. To assign the module, perform the following:

1. Establish communication between the PC and the controller.
2. Remove the tamper switch wire (or only the wire if tamper switch is not used).
3. A serial number should be displayed in the EntraPass message desktop. Look for the type of module and the controller to which it is connected.
4. From the EntraPass controller definition window, select the functionality of the module and enter the serial number in the appropriate field (refer to Chapter 4, Defining Devices or your EntraPass Reference Manual for more details).
5. If the module is used in “repower” mode, assign an “Always valid” schedule to relay 1 and assign the module’s functionality to “relay 1 to 4” in the EntraPass software.

NOTE: Do not forget to reconnect the tamper switch (or the wire, if there is no tamper switch).

NOTE: Ensure that Jumper J1 is set to “Combus Relay” position if used as “repower”.

## KT-PC4216 - 16-Zone Output Expansion Module

### KT-PC4216 Introduction

The KT-PC4216 module is an open-collector to 12 VDC 16-zone output module. Can be used for elevator access control (may require additional hardware).

### KT-PC4216 Specifications

- 16-output low current module, 12 VDC, 50 mA max. each, power drawn from Combus (since Combus can handle a maximum of 500 mA, a KT-PC4204 module in “repower” mode can be used to increase the current of the Combus of 1A).
- Connects to KT-300 via 4-wire Combus
- Nominal current draw of 15 mA
- Tamper contact input
- Can be used for elevator control

### Unpacking the KT-PC4216

The KT-PC4216 package should include the following parts:

- One KT-PC4216 circuit board
- 4 plastic standoffs

### Mounting the KT-PC4216

The KT-PC4216 should be located inside a compatible cabinet (part no. KT-4501CAB), mounted in a dry, secure location. It should be placed at a convenient distance from the connected devices. Perform the following steps to mount the units:

1. Press the four plastic standoffs through the mounting holes at the back of the cabinet.
2. Secure the cabinet to the wall in the desired location. Use appropriate wall anchors when securing the cabinet to drywall, plaster, concrete, brick or other surfaces.
3. Press the circuit board into the plastic standoffs to secure the module to the cabinet.

Wiring may be started once the unit is mounted.

### Installation and Wiring

Before beginning to wire the unit, ensure that all power (AC transformer and battery) is disconnected from the controller. Perform the following steps to complete wiring:

1. Connect the four Combus wires to the KT-PC4216. Connect the Red, Black, Yellow and Green Combus wires to the RED, BLK, YEL and GRN terminals, respectively.
2. Complete all output wiring as illustrated on the next page.
3. Connect the external tamper switch, if used.

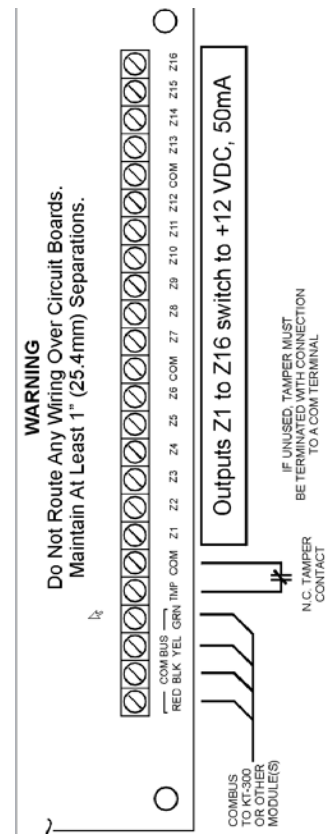

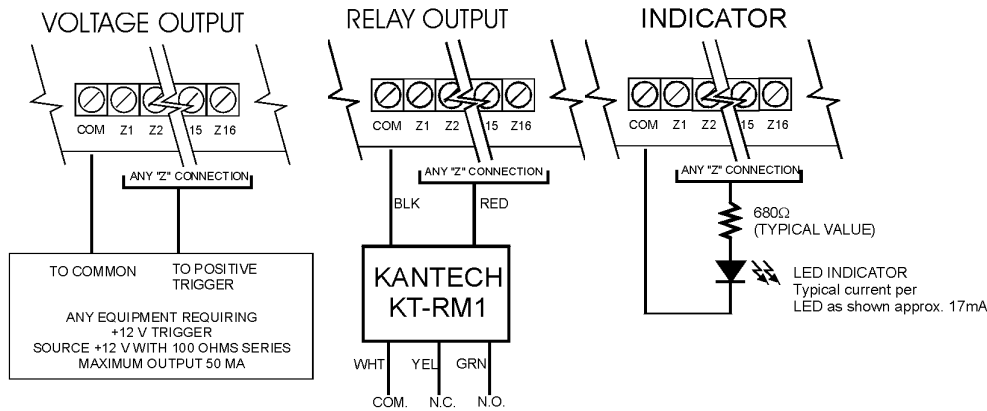

**Applying Power**

1. After all wiring is completed, apply power to the KT-300.
2. Connect the battery leads to the battery.
3. Then, connect the AC transformer.

NOTE: Do not connect the power until all wiring is completed.

**Assigning the KT-PC4216 Module**

Follow the Instructions below for assigning and programming your KT-PC4216 module.

1. Establish communication between EntraPass and the controller.
2. Remove the tamper switch wire (or only the wire if tamper switch is not used).
3. A serial number, the type of module and on which controller it is connected should be displayed on the screen.
4. From the EntraPass user interface, go to the controller definition window and select the functionality of the module and enter the serial number in the appropriate field (refer to *Chapter 4, Defining Devices* of your *EntraPass Reference Manual* for more details).

NOTE: Do not forget to reconnect the tamper switch (or the wire, if there is no tamper switch).

NOTE: If you are using a KT-PC4204 in “repower” mode on the same loop, do not use the first relay of the KT-PC4216.

**KT3-LCD - Kantech LCD Time & Date Display Module**

**KT3-LCD Introduction**

The KT3-LCD module is an LCD readout module with integrated keypad which provides date and time via a 32-character liquid crystal display.

**KT3-LCD Specifications**

- Connects to control panel via 4-wire Combus
- Current draw: 50 mA (from Combus)
- Input status (green), AC Fail (red) and Trouble (yellow) status lights

**Unpacking the KT3-LCD**

The KT3-LCD package includes the following parts/items:

- One KT3-LCD keypad
- Four mounting screws

**Mounting the KT3-LCD**

The keypad should be mounted where it is accessible to designated points to entry/exit. Once a dry and secure location is selected, perform the following steps to mount the keypad:

1. Remove the keypad back plate by loosening the screw located at the base of the unit.
2. Secure the keypad back plate to the wall in the desired location. Use the included screws.



**Wiring the KT3-LCD**

Before beginning to wire the unit, ensure that all power (AC transformer and battery) is disconnected from the control panel.

To complete keypad wiring, connect the four Combus wires (Red, Black, Yellow and Green) to keypad terminals R,B,Y and G.

**Applying Power**

1. Once all wiring is completed, turn the controller on.
2. Connect the battery leads to the battery.
3. Connect the AC transformer.

NOTE: Do not connect the power until all wiring is completed.

**Assigning the KT3-LCD Keypad**

Once all wiring is completed, the module must be assigned to the system. To assign the module, perform the following steps:

1. Establish communication between EntraPass and the controller.
2. Press the pound key (#) on each keypad. A serial number should be displayed in the EntraPass message desktop. Look for the type of module and the controller to which it is connected.
3. From the EntraPass controller definition window, select the functionality of the KT3-LCD and enter the serial number in the appropriate field (refer to *Chapter 4, Defining Devices* of the *EntraPass Reference Manual* for more details).

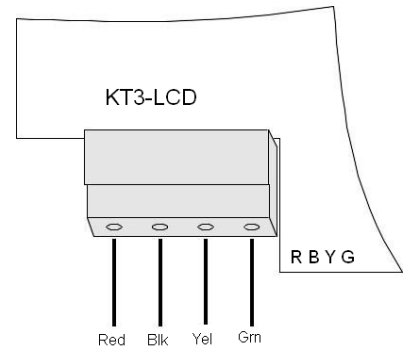

**Troubleshooting Communication Problems**

**Default Initialization**

The KT-300 default initialization is done at Kantech. The following steps should only be followed if:

- a You are using a KT-300 from another site and there is no communication;
- b The KT-300 was communicating via the RS-232 port and you installed a VC-485 to communicate via the RS-485 port;
- c You were using the KT-300 at a local site and now want to configure it for remote operation.

**How to Use the Default Initialization (Hard Reset)**

1. Disconnect both transformer and battery.
2. Remove all connection to DOOR1 and RL1 terminals.
3. Place a jumper between the DOOR1 and RL1 terminals.
4. Apply AC power to the transformer. The VITAL LED should flash 4 times. This means that the controller is in the initialization mode.
5. Remove jumper.
6. Reconnect the battery.

**VITAL LED status indications**

Communication status and other vital controller parameters can be obtained from VITAL LED pulsations. This information is particularly useful when connecting the controller to the rest of the access control system. Consult the KT-300 Controller Wiring Diagram on page 20 to locate the VITAL LED. The following table lists all conditions along with a brief description

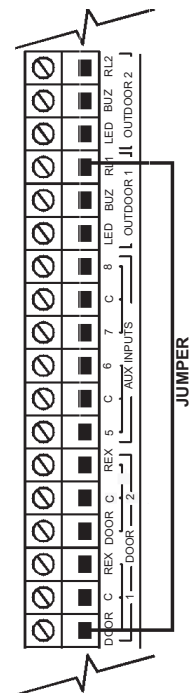

VITAL LED Pulse	Status Identification
1 per second	Communication with EntraPass Global Gateway
2 per second	Communication with master controller, modem online
3 per second	Communication with EntraPass Corporate Gateway
4 per second	Hard reset to factory defaults
Continuous	Offline
0.5 second ON	Reading access card



2.5 seconds ON	Modem confirm
----------------	---------------

**Visual Status Indicators (LEDs)**

The KT-300 controller has multiple status indicators such as for troubleshooting, network activity, power status and outputs activity. Please refer to the graphic below for a detailed view of their location.

- **HEARTBEAT (BLUE):** This LED indicates the working status of KT-300.
- **RS-485 (YELLOW):** The RS-485 port LEDs are transmit/receive activity indicators.
- **RS-232 (YELLOW):** The RS-232 LEDs are ON when communicating to the EntraPass gateway or to the dial-up modem.
- **COMBUS RX and TX (YELLOW):** These LEDs are transmit/receive activity indicators. Only very small packets will be sent/transmitted upon module activity.
- **LOCK1, LOCK2 (RED):** This LED turns ON when the lock output is activated.
- **RELAY1, RELAY2 (RED):** Each relay output has an indicator which turns ON each time the corresponding relay is activated.
- **AC POWER (GREEN):** This LED is on when AC power is present.

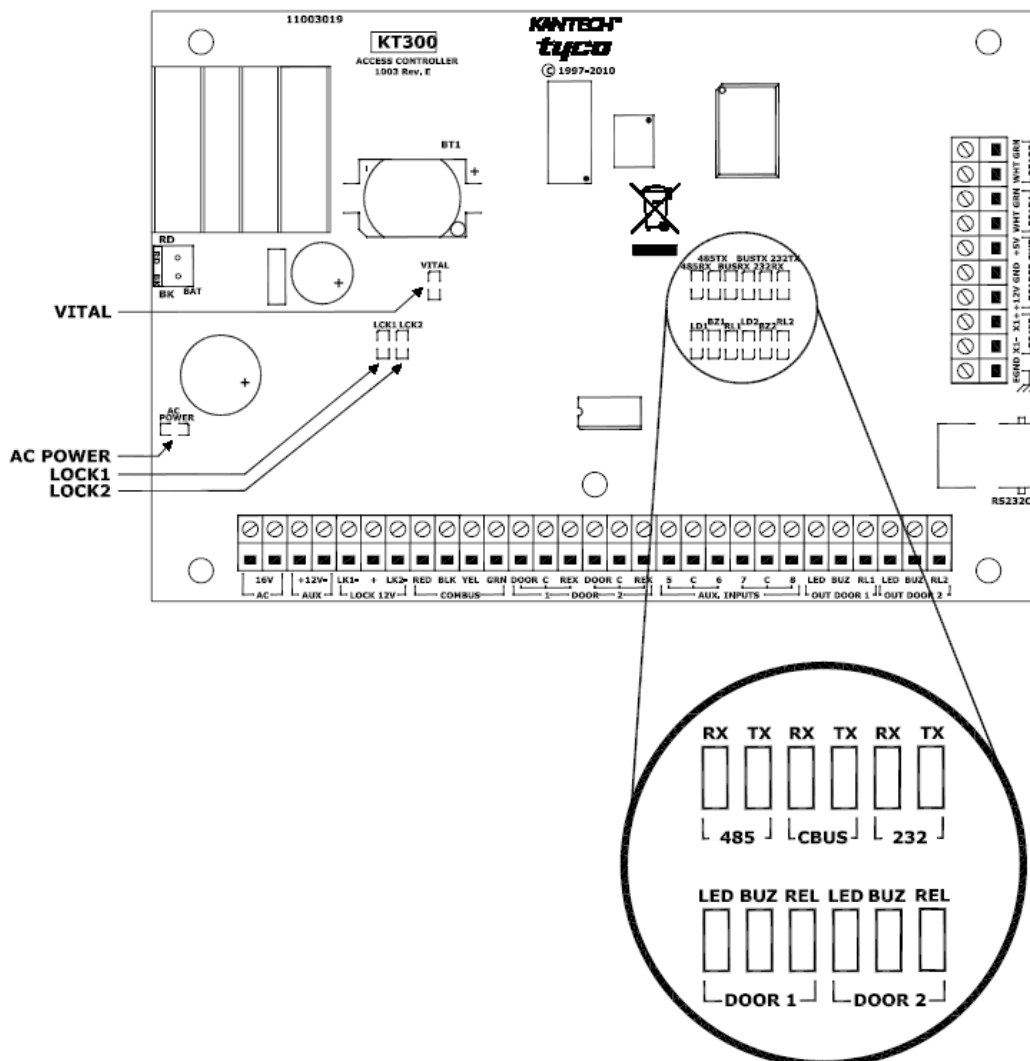

---

## KT-300 Controller Maintenance Recommendations

The KT-300 circuit board includes a lithium battery (see the KT-300 Controller Wiring Diagram on page 20). This battery must be replaced by a Kantech technician to avoid any risk of explosion. If the lithium battery stops working, return the circuit board to Kantech. Do not crush, puncture, open, disassemble or otherwise mechanically interfere with the battery. Do not try to recharge the battery. If you need to dispose of the circuit board and/or the lithium battery, wrap the KT-300 in non-conductive tape. Check with your local authorities for battery disposal regulations.

**WARNING:** *Do not store the batteries in such a way that they come into contact with each other or with any piece of metal. Explosion or fire may occur. Should fire occur, use only dry chemical fire extinguishers. Do not use water to put out the fire. Do not heat the batteries. Do not dispose of the batteries or circuit board in a fire. Do not disassemble the batteries. Do not apply pressure to or deform the batteries. Ensure that the above precautions are strictly observed by related departments, including, but not limited to, production, sales and outside contractors.*

Regarding the recommended battery 7 A/12 V: It is the end-user and/or installer responsibility to assure that the disposal of used batteries is made according to the waste recovery and recycling regulations currently applicable in their area. Use the recommended battery type ONLY.

It is highly recommended to test the KT-300 Controller by performing the following tests:

**1) Bi-annual test for battery:**

Remove AC power from the controller and connect the battery to the controller for one hour. This test will ensure that in the event of a power failure, the battery will be able to support normal operations. This test should be performed twice a year. Once the test has been performed successfully, reconnect AC power to the controller.

**2) Annual test for emergency lithium battery:**

Measure voltage of lithium battery when power is totally removed from the controller (AC & DC power). To ensure maximum operation and prevent loss of power, contact your distributor to return the KT-300 for maintenance if the lithium battery voltage measures below 2.5 VDC.



